

Copper End Cap P

Part No	Size D1	L1 (in)	A1 (in)
PL-CAP12	½"	0.945	0.138
PL-CAP34	¾"	1.063	0.118
PL-CAP1	1"	1.063	0.118
PL-CAP114	1¼"	1.260	0.118
PL-CAP112	1½"	1.693	0.236
PL-CAP2	2"	1.850	0.236

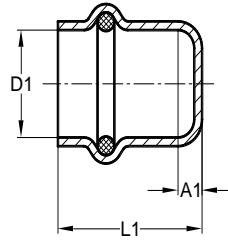

ASME B16.51 / UPC / NSF Certified
 32° - 200° F / 200 PSI / Lead Free Copper
 O-Ring Materials EPDM

Copper Slip Coupling PxP (No Stop)

Part No	Size D1	L1 (in)
PL-C12	½"	1.693
PL-C34	¾"	2.047
PL-C1	1"	2.047
PL-C114	1¼"	2.441
PL-C112	1½"	3.031
PL-C2	2"	3.346

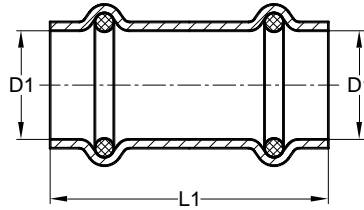

ASME B16.51 / UPC / NSF Certified
 32° - 200° F / 200 PSI / Lead Free Copper
 O-Ring Materials EPDM

Copper Straight Coupling PxP (Stop)

Part No	Size D1	L1 (in)	A1 (in)
PL-CST12	½"	1.614	0.118
PL-CST34	¾"	2.047	0.157
PL-CST1	1"	2.047	0.157
PL-CST114	1¼"	2.441	0.157
PL-CST112	1½"	3.031	0.157
PL-CST2	2"	3.346	0.157

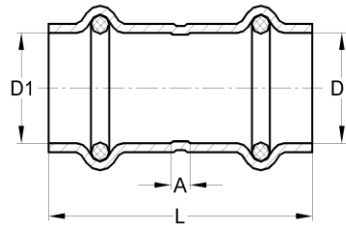

Note
 ASME B16.51 / UPC / NSF Certified
 32° - 200° F / 200 PSI / Lead Free Copper
 O-Ring Materials EPDM

Copper Reducing Coupling PxP (Coupling Reducer)

Part No	Size D1	Size D2	L1 (in)	A1 (in)
PL-RC3412	¾"	½"	2.008	0.335
PL-RC134	1"	¾"	2.165	0.335
PL-RC11434	1¼"	¾"	2.421	0.492
PL-RC1141	1¼"	1"	2.500	0.413
PL-RC1121	1½"	1"	3.031	0.630
PL-RC112114	1½"	1¼"	2.717	0.394
PL-RC21	2"	1"	3.543	0.984
PL-RC2112	2"	1½"	3.386	0.512

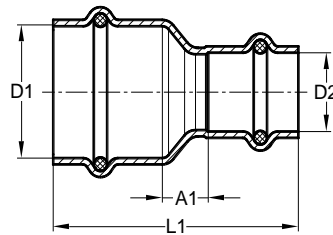

ASME B16.51 / UPC / NSF Certified
 32° - 200° F / 200 PSI / Lead Free Copper
 O-Ring Materials EPDM

Copper Fitting Reducer PxFTG (Bushing Reducer)

Part No	Size D1	Size D2	L1 (in)	A1 (in)
PL-FTG1X12	1"	½"	2.283	1.535
PL-FTG1X34	1"	¾"	2.165	1.260
PL-FTG112X1	1½"	1"	2.835	1.929
PL-FTG112X114	1½"	1¼"	2.835	1.811
PL-FTG2X112	2"	1½"	3.543	2.244

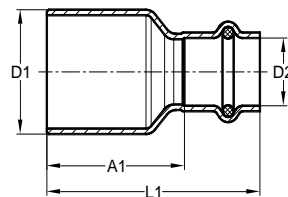

ASME B16.51 / UPC / NSF Certified
 32° - 200° F / 200 PSI / Lead Free Copper
 O-Ring Materials EPDM

Copper Adapter P x FPT (Female Adapter)

Part No	Size D1	Size D2	L1 (in)	A1 (in)
PL-FA12	½"	½" FPT	1.692	0.276
PL-FA34	¾"	¾" FPT	1.811	0.217
PL-FA1	1"	1" FPT	1.890	0.197
PL-FA2	2"	2" FPT	2.638	1.024

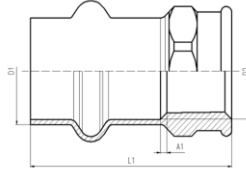

ASME B16.51 / UPC / NSF Certified
 32° - 200° F / 200 PSI / Lead Free Copper
 O-Ring Materials EPDM

Copper Adapter P x MPT (Male Adapter)

Part No	Size D1	Size D2	L1 (in)	A1 (in)
PL-MA12	½"	½" MPT	1.693	0.886
PL-MA34	¾"	¾" MPT	1.890	0.945
PL-MA1	1"	1" MPT	1.929	0.984
PL-MA114	1¼"	1¼" MPT	2.205	1.063

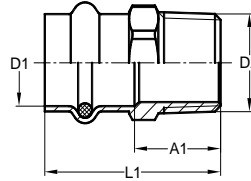

ASME B16.51 / UPC / NSF Certified
 32° - 200° F / 200 PSI / Lead Free Copper
 O-Ring Materials EPDM

Brass Union P x FPT (Female Union)

Part No	Size	A (in)	B (in)	C (in)
PL-FU12	½"	1.949	1.220	0.650
PL-FU34	¾"	2.146	1.240	0.650
PL-FU1	1"	2.303	1.398	0.689

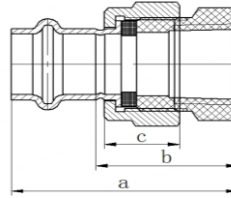

ASME B16.51 / UPC / NSF Certified
 32° - 200° F / 200 PSI / Brass C-46500
 Copper C12200 / O-Ring Materials EPDM

Brass Union P x MPT (Male Union)

Part No	Size	A (in)	B (in)	C (in)
PL-MU12	½"	2.461	1.732	0.650
PL-MU34	¾"	2.736	1.831	0.650
PL-MU1	1"	2.972	2.067	0.689

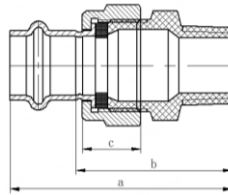

ASME B16.51 / UPC / NSF Certified
 32° - 200° F / 200 PSI / Brass C-46500
 Copper C12200 / O-Ring Materials EPDM

Brass PEX Adapter P x PEX (PEX Adapter)

Part No	Size D1	Size D2	A1 (in)	L1 (in)
PL-PEX12	1/2"	PEX1/2"	0.748	1.732
PL-PEX34	3/4"	PEX3/4"	0.886	1.929

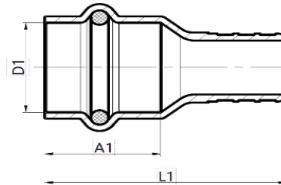

ASME B16.51 / UPC / NSF Certified
 32° - 200° F / 200 PSI / Copper C12200
 O-Ring Materials EPDM

Copper Unequal Tee PxPxP (Tee Reducer)

Part No	Size D1	Size D2	Size D3	L1 (in)	A1 (in)	L2 (in)	A2 (in)	L3 (in)	A3 (in)
PL-RT343412	¾"	¾"	½"	1.634	0.690	1.634	0.690	1.437	0.630
PL-RT1112	1"	1"	½"	1.575	0.669	1.575	0.669	1.890	1.142
PL-RT1134	1"	1"	¾"	1.654	0.748	1.654	0.748	1.634	0.728
PL-RT1141141	1¼"	1¼"	1"	1.988	0.846	1.988	0.846	2.047	1.102
PL-RT1121121	1½"	1½"	1"	2.264	0.807	2.264	0.807	2.087	1.142
PL-RT112112114	1½"	1½"	1¼"	2.244	0.945	2.244	0.945	2.087	1.063
PL-RT2234	2"	2"	¾"	2.323	0.748	2.323	0.748	3.307	2.402
PL-RT221	2"	2"	1"	2.539	0.925	2.539	0.925	2.441	1.535
PL-RT22114	2"	2"	1¼"	2.520	0.945	2.520	0.945	2.362	1.339
PL-RT22112	2"	2"	1½"	2.638	1.063	2.638	1.063	2.598	1.299

ASME B16.51 / UPC / NSF Certified
32° - 200° F / 200 PSI / Lead Free Copper
O-Ring Materials EPDM

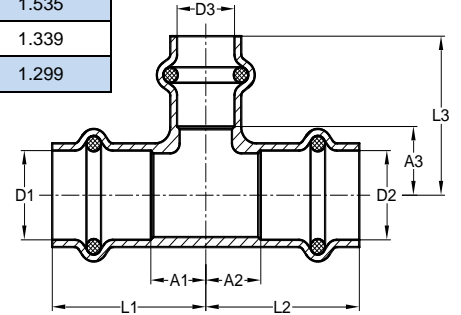

Copper Equal Tee PxPxP (Tee)

Part No	Size D1	L1 (in)	A1 (in)	L2 (in)	A2 (in)
PL-T12	½"	1.555	0.748	1.280	0.472
PL-T34	¾"	1.791	0.846	1.594	0.650
PL-T1	1"	1.909	0.965	1.732	0.787
PL-T114	1¼"	2.126	0.984	1.969	0.827
PL-T112	1½"	2.618	1.161	2.756	1.299
PL-T2	2"	2.992	1.378	3.150	1.535

ASME B16.51 / UPC / NSF Certified
32° - 200° F / 200 PSI / Lead Free Copper
O-Ring Materials EPDM

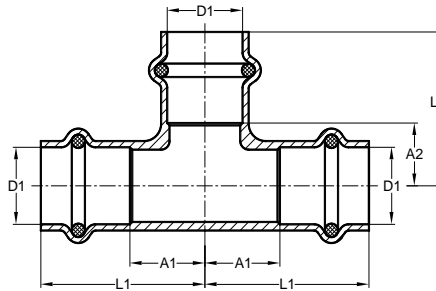

Copper 45° Elbow PxP (45° Elbow)

Part No	Size D1	L1 (in)	A1 (in)
PL-45ELB12	½"	1.102	0.295
PL-45ELB34	¾"	1.398	0.453
PL-45ELB1	1"	1.417	0.472
PL-45ELB114	1¼"	1.969	0.827
PL-45ELB112	1½"	2.303	0.846
PL-45ELB2	2"	2.441	0.866

ASME B16.51 / UPC / NSF Certified
32° - 200° F / 200 PSI / Lead Free Copper
O-Ring Materials EPDM

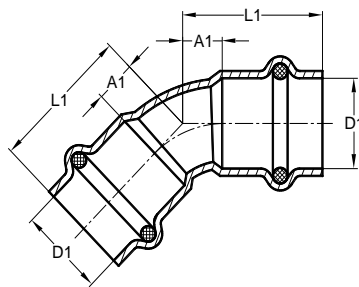

Copper 45° Elbow PxFTG (45° Street Elbow)

Part No	Size D1	AL1 (in)	A1 (in)	AL2 (in)
PL-45STE12	½"	1.102	0.295	1.220
PL-45STE34	¾"	1.398	0.453	1.457
PL-45STE1	1"	1.516	0.571	1.575

ASME B16.51 / UPC / NSF Certified
32° - 200° F / 200 PSI / Lead Free Copper
O-Ring Materials EPDM

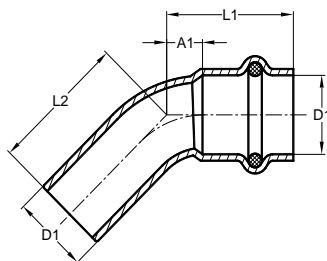

Copper 90° Elbow (Long Radius) PxP (90° Elbow)

Part No	Size D1	L1 (in)	A1 (in)
PL-90ELB12	½"	1.555	0.748
PL-90ELB34	¾"	2.028	1.083
PL-90ELB1	1"	2.244	1.299
PL-90ELB114	1¼"	2.638	1.496
PL-90ELB112	1½"	3.228	1.772
PL-90ELB2	2"	3.780	2.165

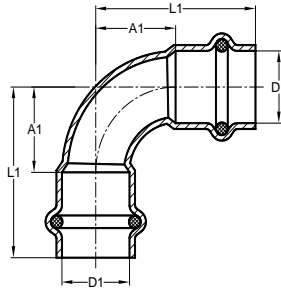

ASME B16.51 / UPC / NSF Certified
32° - 200° F / 200 PSI / Lead Free Copper
O-Ring Materials EPDM

Copper 90° Elbow (Long Radius) PxFTG (90° Street Elbow)

Part No	Size D1	AL1 (in)	A1 (in)	AL2 (in)
PL-90STE12	½"	1.555	0.748	1.772
PL-90STE34	¾"	2.028	1.083	2.165
PL-90STE1	1"	2.244	1.299	2.421

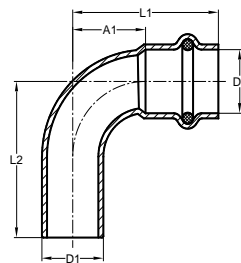

ASME B16.51 / UPC / NSF Certified
32° - 200° F / 200 PSI / Lead Free Copper
O-Ring Materials EPDM

Brass 90° Drop Ear P x FPT (90° Drop Ear Press)

Part No	Size 1	Size 2	L (in)	L1 (in)	L2 (in)	L3 (in)	A (in)
PL-90FPT12DE	½"	1/2"-14NPT	1.575	1.043	0.906	0.591	0.354

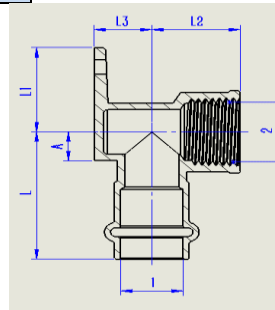

ASME B16.51 / UPC / NSF Certified
32° - 200° F / 200 PSI / Brass C-46500
Copper C12200 / O-Ring Materials EPDM

Brass 90° Drop Ear PEX x FPT (90° Drop Ear PEX)

Part No	Size 1	Size 2	L (in)	L1 (in)	L2 (in)	L3 (in)	A (in)
P-90FPT12DE	½"	1/2"-14NPT	1.280	1.063	0.650	0.413	0.322

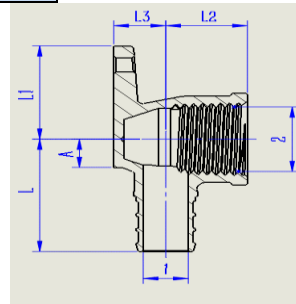

ASME B16.51 / UPC / NSF Certified
32° - 200° F / 200 PSI / Brass C-46500
Copper C12200 / O-Ring Materials EPDM

Uponor PEX to Press

Part No	Size A	L (mm)
PL-PEXA12	1/2"	43.5
PL-PEXA34	3/4"	55.5
PL-PEXA1	1"	58.5

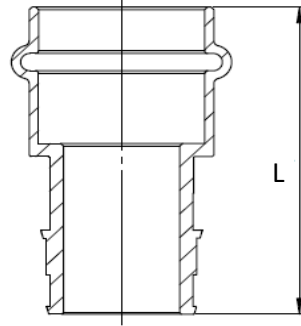
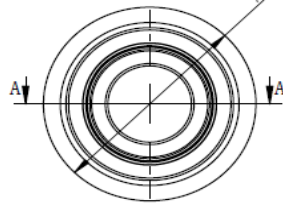

ASME B16.51 / UPC / NSF Certified
 32° - 200° F / 200 PSI / Brass C-46500
 Copper C12200 / O-Ring Materials EPDM